

Getting Started With The Explorer[®] 8300[™] and 8300HD[™] DVR



Record your favorite programs when you're busy

Record one program and watch another

Record two live programs while watching a third program you recorded earlier

Record and store up to 50 hours of standard-definition programs on the 8300 DVR, or up to 20 hours of high-definition programs on the 8300HD DVR

Pause live TV for up to 1 hour without missing a minute

Use instant replay any time you want

Watch two programs at the same time with the Picture-in-Picture feature on any TV you have

Welcome!

With the Explorer® 8300™ Digital Video Recorder (DVR), you can easily record your favorite programs and then play them back anytime. The DVR and Picture-In-Picture (PIP) features give you complete control, convenience, and choice when watching TV. Use your DVR to control the following features...



Control live TV

The telephone is ringing and you do not want to miss any scenes of your favorite live TV program. DVR lets you **PAUSE** the live program, or **REWIND** and **PLAY** a portion of it again, or **FAST-FORWARD** it to catch up to live TV.

Sports fans can enjoy complete control by using **INSTANT REPLAY**, **SLOW MOTION**, and **FRAME ADVANCE AND REWIND** to watch their favorite play again.

Record TV programs without a VCR

RECORD and save your favorite TV programs to the DVR to watch later.

When two of your favorite TV programs are scheduled at the same time, **RECORD** one program to the built-in recorder while watching the other!

Never miss your favorite programs that are scheduled at the same time. Simply **RECORD** both programs at the same time. While recording both programs, you can play back a third program you have already recorded.

RECORD a single episode or all episodes of your favorite TV programs.

RECORD one of your favorite TV programs and at the same time, access any advanced application, such as video-on-demand (VOD).

Not sure if you have room to **RECORD** new programs? You can check your available recording space any time.

Watch two TV programs at the same time

PIP is built into the Explorer 8300 DVR, so you can watch two live programs at the same time on any make or model TV that is connected to your DVR.

When something exciting occurs in the PIP program, you can easily swap the PIP into the Main screen. Once that program is in the Main screen, you can pause, rewind, or record it.

When the PIP screen position is covering a "must see" moment on the Main screen, simply **MOVE** the PIP screen to a different corner of your TV screen.

Let's Get Started!

Using Your Remote Control

Use the keys on the AllTouch Remote Control to access the DVR and PIP features of your DVR.

This guide describes the keys used to access the DVR and PIP features. For descriptions of the other key functions, refer to the user's guide for your remote control model:

- AT8400™ AllTouch Remote Control User's Guide, part number 749219
- AT8450™ AllTouch Remote Control User's Guide, part number 4001707
- AT8550™ AllTouch Remote Control User's Guide, part number 4006383

Important: Your remote control must be set to Cable Mode (CBL) to access the DVR features.

AllTouch AT8400 Remote Control

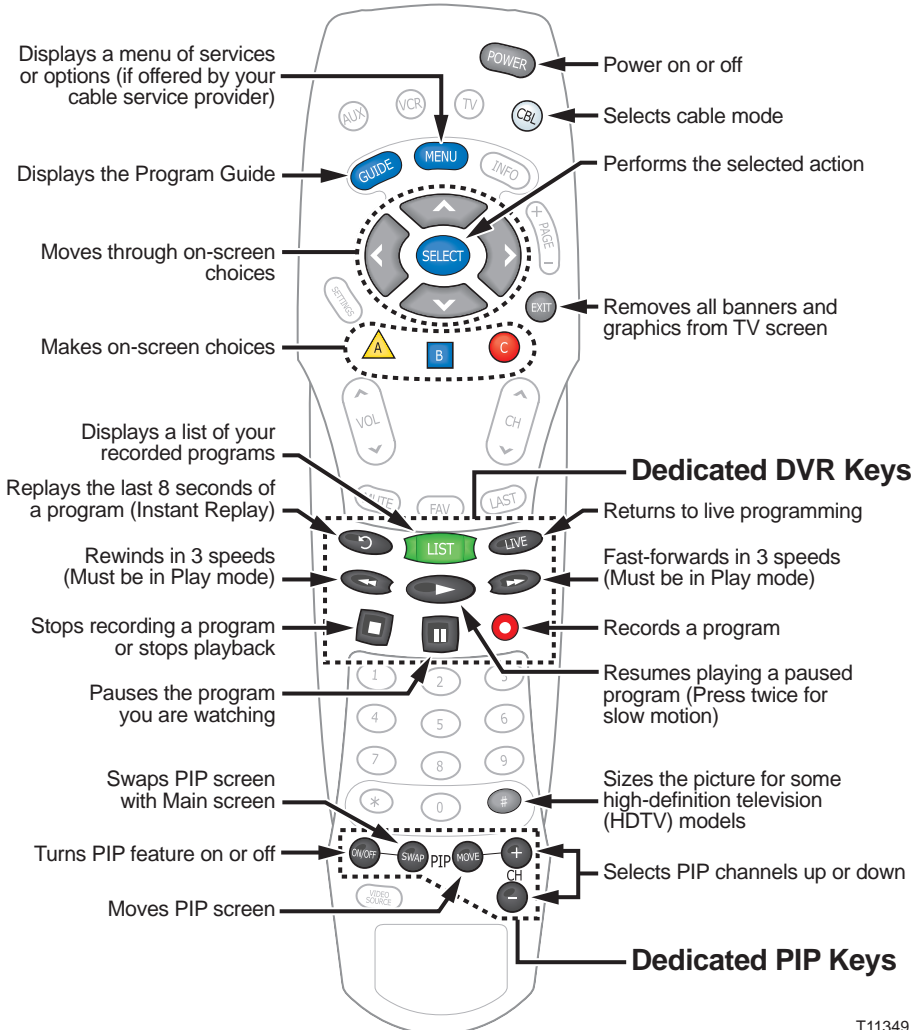

Preparing the Explorer 8300HD DVR to Work With Your High-Definition TV

First make sure that your DVR is properly connected to your HDTV television and other electronic devices. Use the component (PrPbY) or HDMI™ ports to connect the DVR to your HDTV.

For more information, refer to the connectivity guide for your DVR model:

- *Connecting the Explorer® 8300™ Digital Video Recorder*, part number 4003987
- *Connecting the Explorer® 8300HD™ Digital Video Recorder*, part number 4003986

Note: The composite ports (red, yellow, white) and the component ports (PrPbY) on the back of the 8300HD are both active simultaneously.

Selecting HDTV Picture Formats With the HDTV Setup Wizard

The following section provides instructions for using the HDTV Setup Wizard to select HDTV picture formats using the Easy and Advanced Setup modes.

Start the HDTV Setup Wizard

To start the HDTV Setup Wizard, follow these steps.

1. Make sure that the DVR is powered **OFF**, but still plugged into an active power outlet, and connected to the HDTV using the proper connectors (HDMI or Component for an HDTV; Composite, RF, or S-Video for a SDTV).
2. Turn the TV **ON**.
3. With the DVR powered **OFF**, press **Guide** and **Info** at the same time. The **HDTV Setup Wizard** screen appears.
4. Press  to start the set up.
5. Choose one of the following options:

*Press the **Guide** and **Info** keys at the same time*



- To choose the Easy Setup option press ; then, go to the **Easy Setup Instructions** on page 5.

Note: Choosing the Easy Setup mode limits your HDTV picture formats to 480i and 1080i, depending on the TV type you select.

- To choose the Advanced Setup option press ; then, go to the **Advanced Setup Instructions** on page 5.

Note: Choosing the Advanced Setup mode allows you to save all the HDTV picture formats, so that you can toggle between them easily while watching TV.

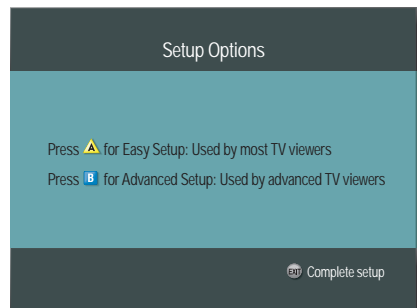

Easy Setup Instructions

1. Press **A** or **B** to select the type of TV screen you have. The setup is complete.
2. Press **Power** to begin watching TV.

Notes:

- If you pressed **A** for the standard screen (4:3) TV setting, the TV is set to receive programming in 480i format on non-HD channels and 1080i format on HD channels.
- If you pressed **B** for the widescreen (16:9) TV setting, the TV is set to only receive programming in 1080i format (even on non-HD channels).

Tip: After you complete the setup, you can use **#** to stretch or zoom the picture.

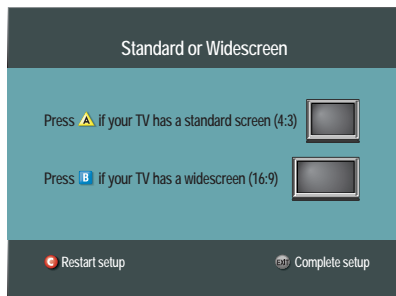

Advanced Setup Instructions

1. Press **A** or **B** to select the type of TV screen you have.
2. Follow the on-screen instructions to select your picture formats.
3. Press **SELECT** to toggle between the Save and Remove options, or press **B** to see how the next format looks on your TV screen.

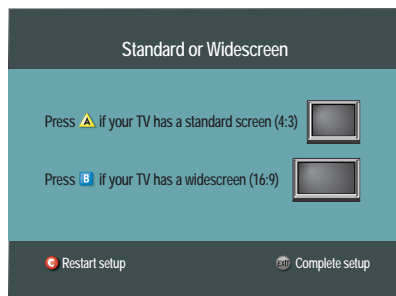

Note: If you see a black screen *do not* press **SELECT**. Press **B** again to view the next screen format.







4. After saving the picture formats, press **EXIT**. The setup is complete.
5. Press **POWER** to begin watching TV.

Tip: After you complete the setup, you can use **#** to stretch or zoom the picture.

Select Picture Mode for Normal Viewing

After you use the HDTV Setup Wizard to select all the HDTV picture formats you want to use, you need to choose a General Settings picture mode for normal viewing. If you do not have your HDTV connected to the HDMI connector on the back of the 8300HD DVR, then Pass-Through mode is recommended for normal viewing. Pass-Through mode allows non-HD channels to be displayed using their native picture formats, which can improve picture quality on non-HD channels.

To select Pass-Through mode for normal viewing, follow these steps.

1. Press **Settings**  twice. The **General Settings** menu appears.
2. Press **Move Up**  or **Move Down**  to highlight **Set: Picture Format**.
3. Press **Move Right**  to highlight the picture format setting.
4. Press **Move Up**  to select **Pass-Through**.
5. Press **Accept**  to use this option for the 8300HD. The DVR front panel displays **AUTO**, plus the scan rate you are viewing (for example, 1080i).
6. Press **Exit**  to return to normal viewing.

Note: When the HDMI connector is connected to the HDTV, the **General Settings - Set: Picture Format** screen displays the AutoDVI/HDMI option instead of the Pass-Through option.

Important: Do not connect the HDMI (DVI) output to a HDTV that does not support High-Definition Copy Protection (HDCP). If you connect the HDMI (DVI) output cable to a HDTV that does not support HDCP, you will not be able to see any video output. A message will be displayed instructing you to disconnect the HDMI connection and watch video output through the PrPbY component connectors.

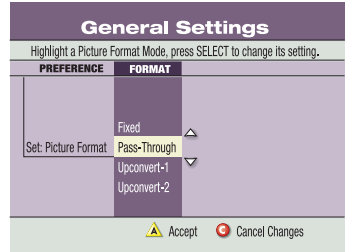

Important Note Regarding the HDMI Interface

The High-Definition Multimedia Interface (HDMI) is an all-digital audio and video interface. HDMI provides a digital interface between any audio and video source. HDMI supports standard, enhanced, or high-definition video, plus digital audio.

Some HDTVs do not contain circuitry to decode Dolby® Digital formatted content. If you connect your DVR to an HDTV that cannot support Dolby Digital audio, the HDMI interface instructs the DVR to switch its audio outputs to 2-channel PCM audio (to be compatible with the HDTV). In this case, all digital audio outputs on the DVR are formatted as 2-channel PCM. As a result, you will not be able to receive Dolby Digital or DTS audio on your home theater system when connected to either the optical or coax (RCA Connector) S/PDIF ports. You can avoid this by overriding the automatic configuration through the General Settings menu and switching the audio output to Dolby Digital.

Important: If your HDTV cannot decode Dolby Digital formatted content and you have configured the DVR to output in the Dolby Digital format, you will *not* be able to listen to audio through the TV. Instead, you must use your home theater or your Dolby Digital decoding device in order to hear audio. Alternatively, you can reconfigure the DVR to output 2-channel PCM any time you want to use the TV to produce the audio portion of the content by selecting HDMI in the General Settings - Audio Output screen. Depending upon your equipment capabilities to select alternate audio sources for input, other configurations may be possible. Refer to your equipment user's guides for more information.

Controlling Live TV

Control a Live Program You Are Watching

Use the following remote control keys to control the live program in the Main screen:

The **Pause**, **Rewind**, **Fast-Forward**, **Play**, **Instant Replay**, and **Live** keys on the remote control are used to control the live program in the Main screen.

For example, when you are watching your favorite live TV program and the telephone rings, press **Pause** to pause the program for up to 1 hour. From **Pause** mode, press **Pause** or **Play** to resume the normal play mode.

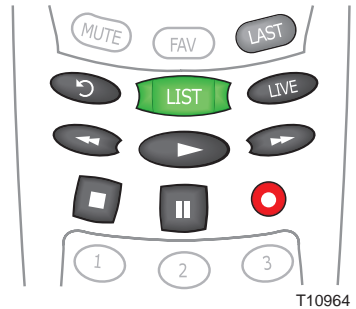

While in normal play mode, press **Rewind** or **Fast-Forward** to cycle through three different speeds of rewind or fast-forward.

To reverse or advance one frame at a time, press **Pause** and then repeatedly press **Rewind** or **Fast-Forward**. For example, to advance three frames, press **Pause** and then press **Fast-Forward** three times.

To see the action in slow motion, press **Play** from normal play mode. Press **Play** again to resume normal play mode.

To replay the last 8 seconds of a live or recorded program, press **Instant Replay**.

If you have rewound or paused a live program, press **Live** at anytime to catch up to the live TV program.

Note: You can use these same dedicated DVR keys to control the reduced screen (also known as the quarter screen) in the Program Guide and in all DVR screens.

Pause a Live Program

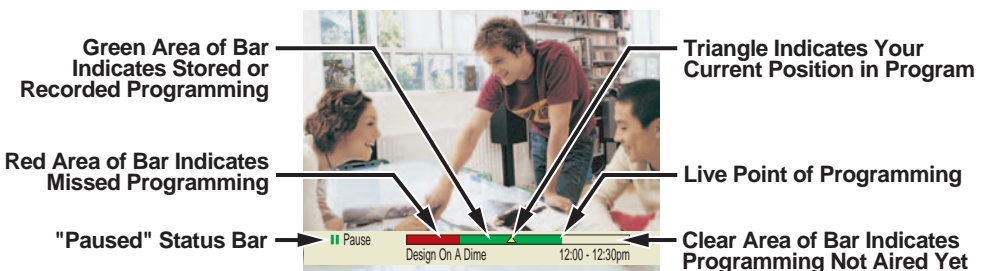

The paused status bar appears when you press **Pause**.



Note: All of the features for controlling live TV (such as Pause, Fast-Forward, Rewind) are also available when playing back recorded programs.





Using the Program Guide

Find a Program to Watch





1. Press **Guide** . The Program Guide appears and lists the next 7 days of programs.
2. Press the **directional keys**  to move through the program listings and highlight the program you want to watch.
3. Press **Select** . If the program is currently on, the Program Guide closes and the program you selected appears in full-screen TV. If the program is on in the future, a future program option screen appears.



Search for a Program by Channel, Title, or Theme



1. Press **Guide** . The Program Guide appears and lists the next 7 days of programs.
2. Press **Browse By** . The Browse By area of the Program Guide displays the options Title, Channel, and Theme.
3. Press **Move Up**  or **Move Down**  to highlight one of the following options:
 - **Channel**, which lists programs numerically by channel number
 - **Title**, which lists programs alphabetically by program title
 - **Theme**, which lists programs by theme, such as adventure, comedy, sports, or news
4. Press **Select** . The Browse By area of the Program Guide displays the programs according to the option you selected.

Search for a Program by Date

1. Press **Guide** . The Program Guide appears and lists the next 7 days of programs.
2. Press **Date** . The Browse By area of the Program Guide displays the next 7 dates.
3. Press **Move Up**  or **Move Down**  to highlight a date.
4. Press **Select** . The Program Guide displays the programs that will be broadcast on that date.



Recording TV Programs

Record a TV Program You Are Watching

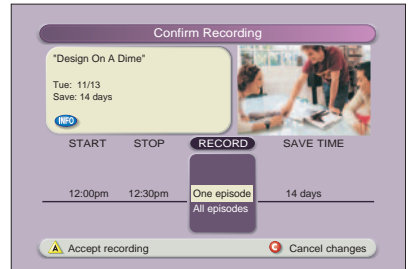
1. Press **Record** .
2. While in the **Confirm Recording** screen, choose your recording options and press . The **Record Indicator** is lit on the front panel of the DVR.
3. To manually stop recording before the scheduled time, press **Stop**  and then follow the on-screen choices.





Record a TV Program From the Program Guide

1. Press **Guide** .
2. Press the arrow keys to highlight a TV program, and then press **Record** .
3. In the **Confirm Recording** screen, choose your recording options and press . The recording program is highlighted in red in the Program Guide.



Record Multiple Episodes of a TV Program

If you want to record all the episodes of a program you are watching, follow these steps:

1. Press **Record** .
2. Choose **One Episode** or **All Episodes**. Notice the information in the fourth column changes, based on your selection. Press . If you selected **All Episodes** from the third column, the **All Episode Recording Options** screen appears.
3. Choose one of the options on the screen.
4. Press **Select**  to save your settings. **Note:** The "New first-run episodes on this channel" option is subject to availability in your area.

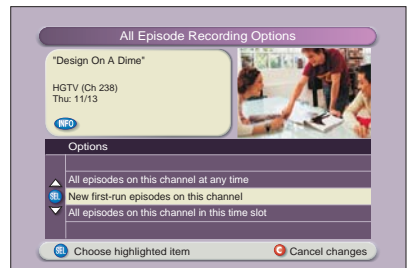
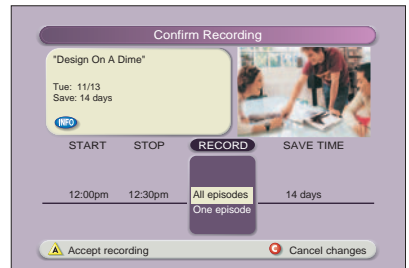

Watching Your Recordings

Access and Play Back Your Recorded Programs Anytime

1. Press **List** **LIST**.
2. Use the arrow keys to choose the program you want to play back.
3. Press **Select** **SELECT** to display your options.

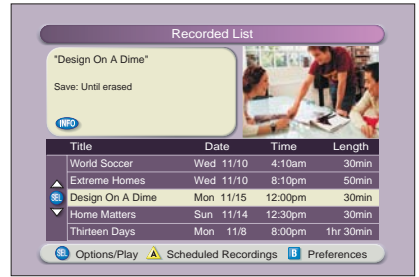

Access and Play Back Your Recorded Programs From the Program Guide

1. Press **Guide** **GUIDE**.
2. Use the arrow keys to choose the **DVR** channel and press **Select** **SELECT**.
Note: The DVR channel is a dedicated channel that allows you to play back your recorded programs.
3. Use the arrow keys to choose the program you want to play back.
4. Press **Select** **SELECT** to play back the program.



Managing Recording Space

How Much Recording Space Do I Have?

1. Press **List** **LIST**.
2. Press **B** to display the Preferences screen, which displays the percentage of space used.

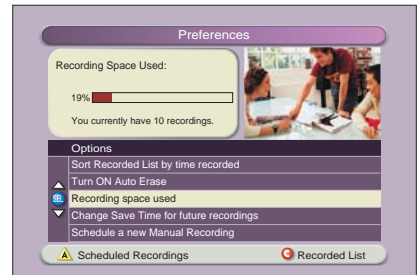

Automatically Erasing Oldest Recordings If Space Is Needed

Turning Auto Erase on will automatically erase your oldest recordings one by one until there is enough space to record your new programs.

Note: Any recordings that have a Save Time of "Until I Erase" will not be automatically erased.

1. Press **List** **LIST**.
2. Press **B** to display the Preferences screen.
3. Choose **Turn ON Auto Erase**.



Copy Recordings From Your DVR to a VCR Tape

The Copy to VCR feature lets you copy recordings from your DVR to a VCR tape.



Warning: Avoid electric shock. Unplug all electronic devices before connecting or disconnecting any device cables to the DVR.

Verify that the **OUT 2** outputs are connected to your VCR inputs.

Note: This graphic shows the 8300HD DVR back panel layout. The 8300 DVR back panel is slightly different.

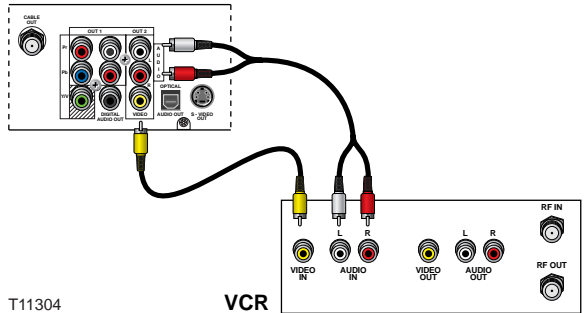









The program that you are copying appears in the *PIP window*. Connecting to your VCR using the **OUT 2** outputs allows you to watch or record another program or even change channels in the Main screen, without affecting the copy in progress.

Notes:

- You can turn the PIP feature off and on without affecting the copy in progress. A “Copying to VCR” banner will be displayed for 3 seconds when you turn the PIP feature on.
- You can still record live TV directly to a VCR tape (instead of your DVR) by connecting the DVR **OUT 2** outputs directly to the VCR inputs and not using the **Copy a Recording to a VCR Tape** instructions on page 13. Recording live TV directly to your VCR causes the VCR to record all remote control activities, including information banners and on-screen displays such as when **Guide**  is pressed.

Copy a Recording to a VCR Tape

1. Connect the VCR to the **OUT 2** connection on the back of the Explorer DVR. See page 12 for more information.
 2. Make sure that a tape is in your VCR and that the VCR is set to record.
 3. Press **List** . The Recorded List screen appears.
 4. Press **Move Up**  or **Move Down**  to highlight the recording you want to copy to the VCR. Make sure to select a program that is not currently being recorded.
 5. Press **Select** . The Recorded Program Options screen appears.
 6. Press **Move Up**  to highlight "Copy to VCR."
 7. Press **Select** . The Copy to VCR screen appears.
 8. Make sure your VCR is properly connected to your DVR outputs, and press **Record** on your VCR.
 9. Press **Start copy** . The recording begins copying to VCR tape. The Recorded List displays the VCR symbol  for the recording that is copying to VCR.
- Note:** You can watch the copying in progress through the PIP.

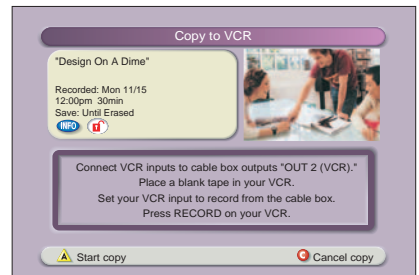
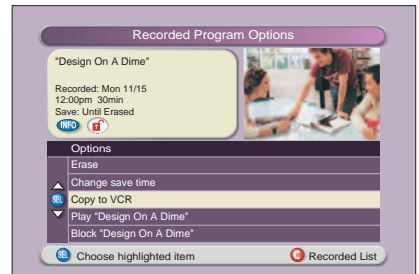
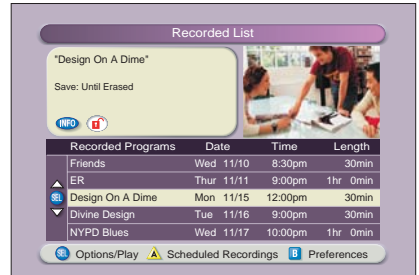



Using Picture-In-Picture

Activate PIP on Your TV

While watching a program, press **PIP On/Off**  to activate the PIP screen.

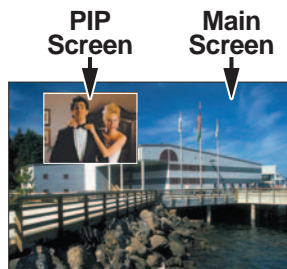

Notes:

- To pause or record the video in the PIP screen, you must first swap it to the Main screen.
- You can only use the dedicated DVR keys (**Pause, Rewind, Fast-Forward**) to control the program shown in the Main screen.
- To change the channel in the PIP screen, use **PIP CH+**  and **PIP CH-** .



Tip: While the PIP screen is activated, press **INFO**  to display a channel banner for both the Main screen and the PIP screen.

Activate PIP From the Program Guide

From the Program Guide, press **Exit**  or **Guide**  to close the Program Guide, and then press **PIP On/Off**  to activate PIP. You can only activate PIP from full-screen video.

Swap the Main and PIP Screens

To swap the TV program that is in the PIP screen to the Main screen, press **PIP Swap** .

Note: You will only hear the audio for the program shown in the Main screen.

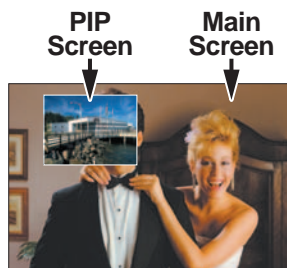

Move the PIP Screen

To move the PIP screen clockwise to a different corner of the Main screen, press **PIP Move** . You can move the PIP screen to any of the four corners of the Main screen.

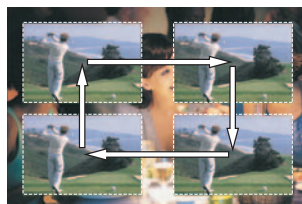

Use Power-Save Mode

To maximize the life of your DVR, you should power-down the DVR when it is not in use. Simply press **CBL** and then **Power** on your remote control, or press **Power** on the front panel of the DVR. The Power light turns off; but, because the DVR is still plugged in, your scheduled recordings still occur.

Between 1:00 a.m. and 6:00 a.m. daily, your DVR will automatically enter Power-Save mode unless you press a key on the remote control or a key on the DVR front panel at least once every 2 hours. In Power-Save mode, the set-top is powered-down, but all scheduled recordings still occur. When the DVR enters Power-Save mode, your TV displays a black screen. **Note:** Your cable service provider controls whether or not the automatic Power-Save mode is activated on your set-top.



At 1:10 a.m., the DVR displays the above 5-minute warning banner, indicating that the DVR is about to enter power-save mode. When this banner appears, do one of the following:

- To allow the DVR to enter Power-Save mode, do nothing when the warning banner appears. The DVR will automatically power-down. After your DVR powers down, you must press **CBL** and then **Power** on your remote control, or press **Power** on the front panel of your DVR to start watching TV again.
- To prevent the DVR from entering Power-Save mode, simply press any key on your remote or any key on the front panel of the DVR when the warning banner appears. The DVR will not attempt to enter power-save mode again until another 2 hours of inactivity has passed.

Frequently Asked Questions

How far back can I rewind live TV? The length of time you can rewind live TV depends on how long you have been tuned to a single channel. Each time you change channels, a new copy is automatically stored to the built-in recorder. This copy saves up to the last 1 hour of programming. For example, if you have been watching the same channel for 15 minutes, you can rewind that 15 minutes of the program.

Can I record the quarter screen in the Program Guide or the DVR Recorded List? Yes, you can record the quarter screen on all DVR screens by pressing **Record**. You can also record the quarter screen in the Program Guide. Press **Exit** to display the video in full screen, and then press **Record**.

Note: Pressing **Record** while in the Program Guide will record the highlighted program in the grid.

Can I record or pause the video in the PIP screen? Yes, but you must swap it to the Main screen first. After pressing **Record** and confirming the recording, you can swap it back to the PIP screen and it will continue recording. You can also press **PIP On/Off**, and the video will continue to record.

Can I use PIP while copying a program to my VCR? When copying a program to a VCR, the PIP can be used only to monitor the progress of the copy status. You cannot use PIP to watch another program while copying a program to a VCR.

If I've been tuned to a program since it started, do I have to rewind to the beginning to record the entire program? No, if you have been tuned to the program since its beginning, just press **Record** from any point in the program to record the entire program. Recording will automatically stop when the program ends.

How will I know the DVR is almost out of recording space? When you try to schedule the next recording, a warning appears on the Confirm Recording screen. Also, you can see what percentage of recording space you have used. Press **List** and then press **B** for preferences.

What happens if my DVR loses power temporarily? Everything you have recorded is saved, based on the save time you selected in the Confirm Recording screen. Your scheduled recordings during the time the DVR lost power are the only recordings you may miss.

Do my Parental Controls in the Program Guide carry over to DVR recordings? Yes. If you block programs by channel or rating in General Settings menu, those settings are carried over to DVR recordings. For example, if you decide to block all R-rated programs in the General Settings menu, the R-rated programs will still be recorded, but you cannot play them back until you enter the correct PIN.

How do I block or erase individual recordings in my recorded list or change the save time for the recording? Highlight the recording on the Recorded List screen, and press **Select** on the remote control. An Options screen appears for the program you selected.

Why are all my programs displayed in 1080i format? You may have selected the Easy Setup mode and the Widescreen (16:9) TV setting in the HDTV Setup Wizard. Choosing these two settings together limits your programming to 1080i format, even on non-HD channels. To see your non-HD programs in 480i on a widescreen (16:9) HDTV, use the Advanced Setup in the HDTV Setup Wizard. Make sure that you select 480i as one of your saved formats, and then select **Pass-Through** in General Settings: Picture Format for your default picture format.



© 2004 Scientific-Atlanta, Inc. All rights reserved.

AllTouch, Explorer, Scientific-Atlanta, and the Scientific-Atlanta logo are registered trademarks of Scientific-Atlanta, Inc. 8300, 8300HD, AT8400, AT8450, and AT8550 are trademarks of Scientific-Atlanta, Inc.

Dolby is a registered trademark of Dolby Laboratories.

HDMI, the HDMI logo, and High-Definition Multimedia Interface are trademarks or registered trademarks of HDMI Licensing LLC.

All other trademarks shown are trademarks of their respective owners. Product and service availability subject to change without notice.

Scientific-Atlanta, Inc., 5030 Sugarloaf Parkway, Box 465447, Lawrenceville, GA 30042
www.scientificatlanta.com

August 2004 Printed in USA.

4004007 Rev A

For questions or comments, call your cable service provider.